

Tuile du Nord 44

DAKOPLOSSINGEN



Technische
informatie

Tuile du Nord 44

De Tuile du Nord 44, medio 1880 ontwikkeld in Frankrijk, is een goedsluitende vlakke dakpan. Het rechte gedeelte van deze dakpan is voorzien van een ronde wel. Door deze combinatie ontstaat een elegant verticaal lijnenspel op het dakvlak. Daken gedekt met Tuile du Nord dakpannen hebben een tijdloze, evenwichtige en rustige uitstraling.

Toepassing

De Tuile du Nord 44 wordt vaak toegepast op villa's en woningen met gevarieerde dakvormen. Deze dakpan scheidt ruimte voor tal van creatieve ideeën en originele uitwerkingen.

Afwerking

Bij de Tuile du Nord 44 hoort een breed assortiment hulpstukken dat speciaal voor dit model is geproduceerd. Hiermee kan het dak zowel technisch als esthetisch perfect worden afgewerkt.

Kleuren

De keramische dakpan is een natuurproduct. Geringe kleurnuanciering is inherent aan keramische producten. Het verdient daarom aanbeveling dakpannen uit alle pakketten door elkaar te verwerken.

30 jaar garantie!

wienerberger levert al haar keramische dakpannen met een unieke garantie van dertig jaar op breuksterkte, waterdichtheid en vorstbestendigheid.



natuurrood



lustre engobe



blauw gesmoord



zwart verglaasd



rustiek engobe



leikleur mat verglaasd



oud koper engobe



oud latem rood



antraciet engobe



oud latem blauw

Technische specificaties

Vlakke dakpan met dubbele kop- en zijsluiting

Afmetingen (b x l)	221 x 304 mm
Latafstand	248 mm
Dekkende breedte	195 mm
Gewicht	1,9 kg/stuk
Aantal per m ²	20,7
Minimum dakhelling	25°
Panhaak	Twintikker TdN 44 / 993 rvs

Gegeven maten zijn nominaal, conform NEN-EN 1304.
 Inherent aan het productieproces zijn kleine maatafwijkingen mogelijk.
 Wij adviseren om voor plaatsing eerst de juiste maatvoering van de dakpannen en hulpstukken te bepalen.
 Voor dakhellingen beneden de 25° gelden nadere eisen. Neem hiervoor contact op met de afdeling
 Bouwtechniek & Services van wienerberger, tel. 088 - 11 85 111.

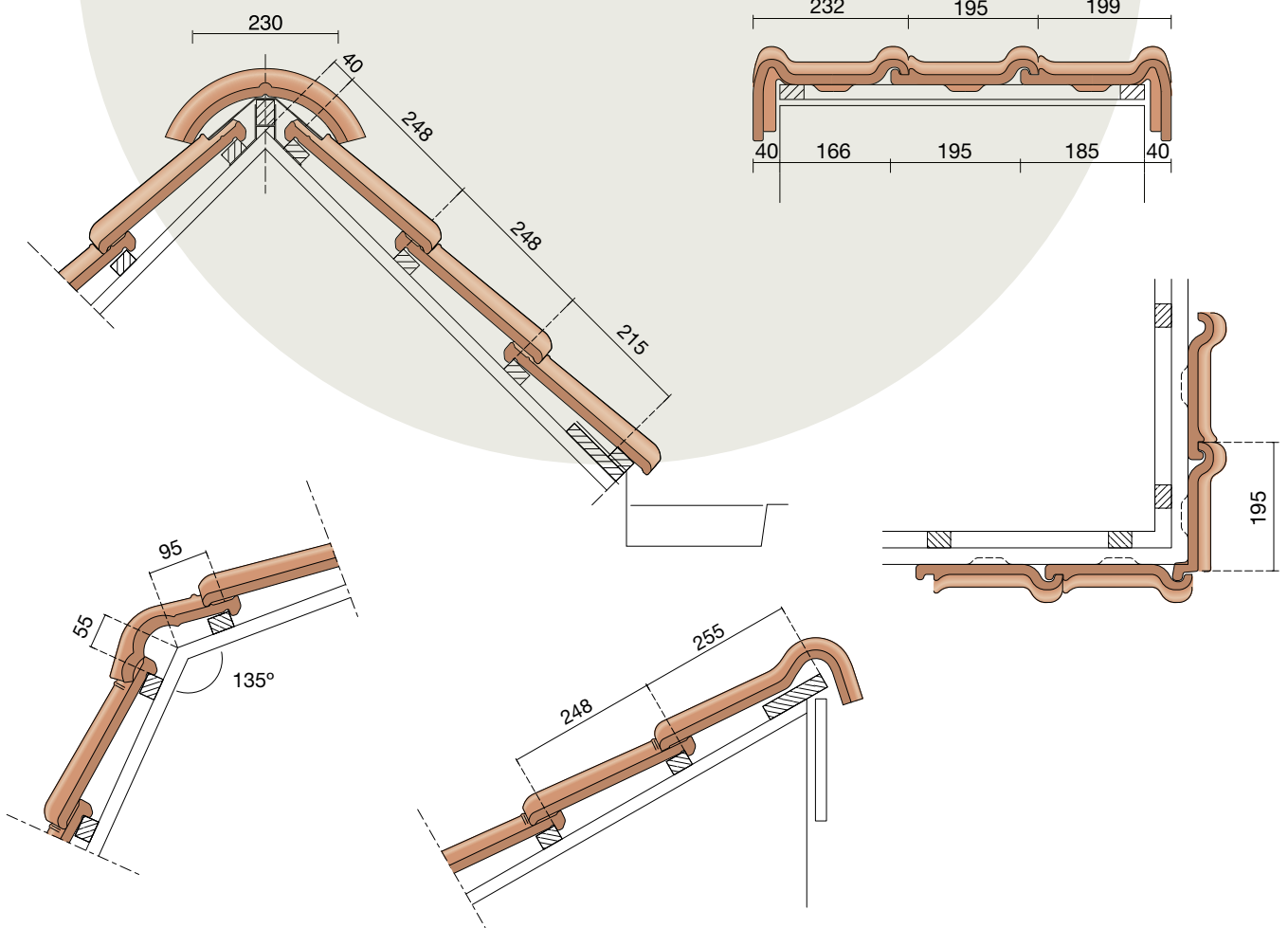
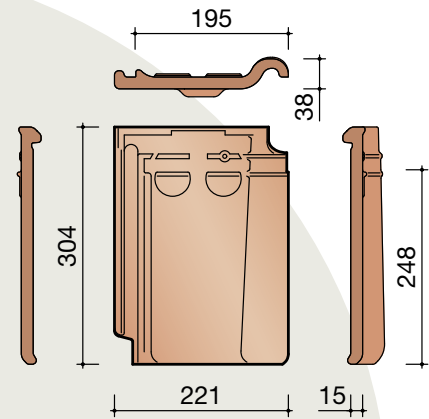

Nok- en hoekkepervorsten

1230 Halfronde vorst met dubbele sluiting

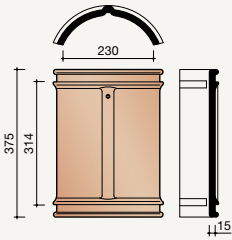

1200 Halfronde vorst

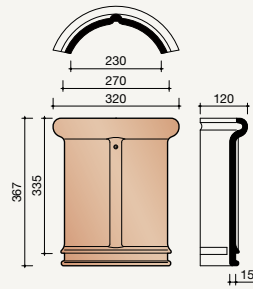

1240 Kopplaat begin /eind

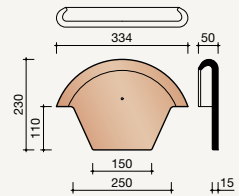

1260 Halfrond beginkapje

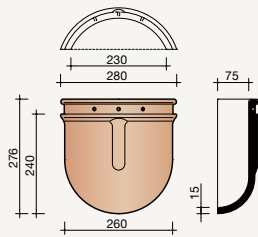

1200 Halfronde vorst

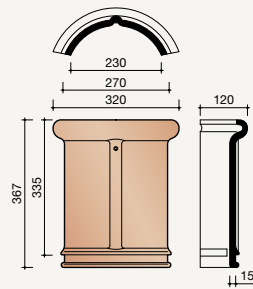

3110 Halfrond beginkapje

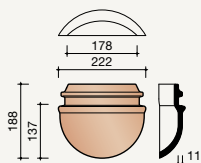

3100 Halfronde hoekkepervorst

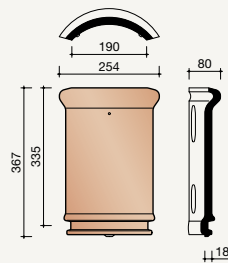

Gevelpannen

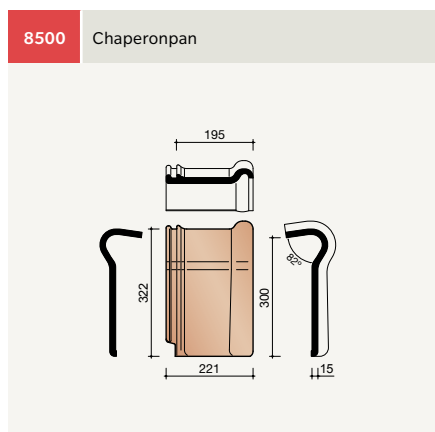
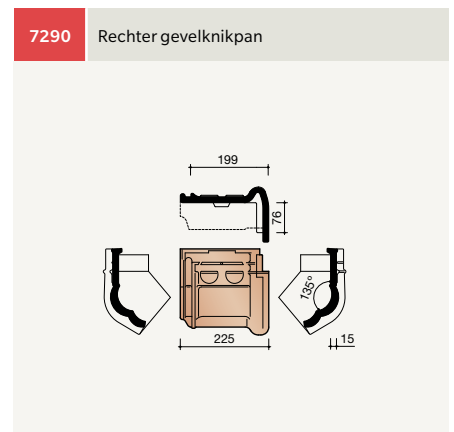
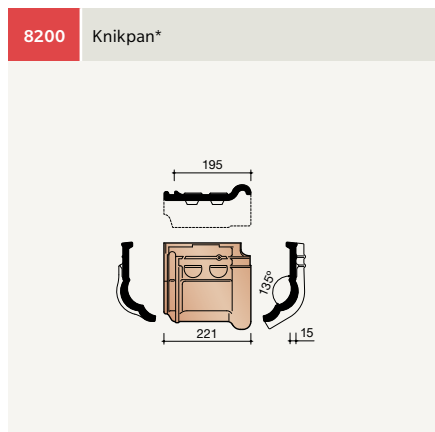
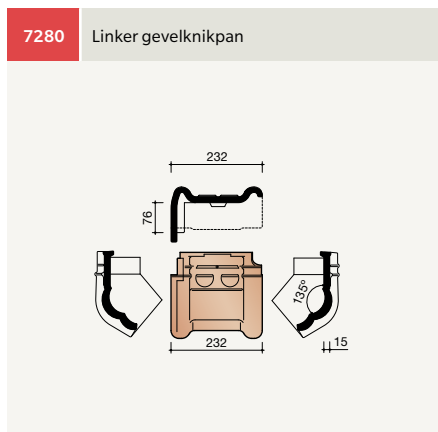
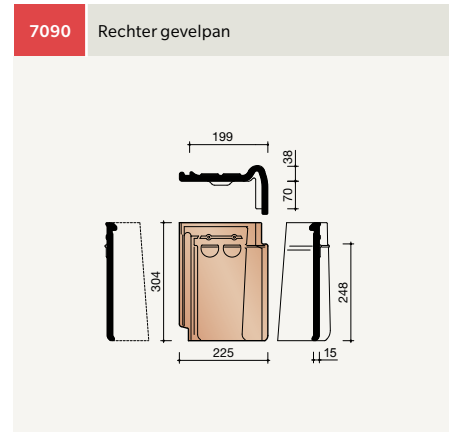
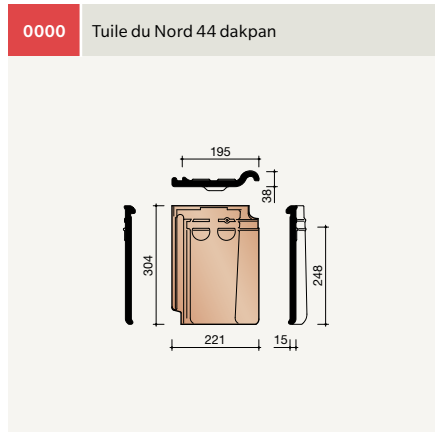
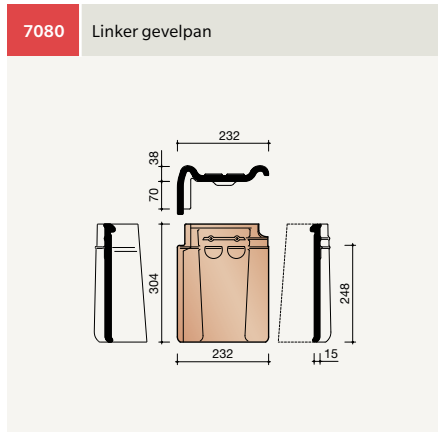

*Ook leverbaar op maat (verlijmd), zie overige hulpstukken (pag.6)

Overige hulpstukken

8050 Pan met dubbele wel

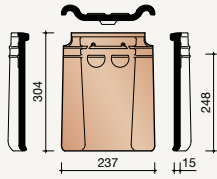

8030 Driekwart pan

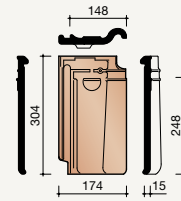

8200 Nikpan op maat (verlijmd)*

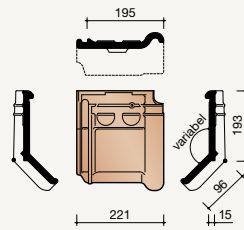

8230 Driekwart nikpan

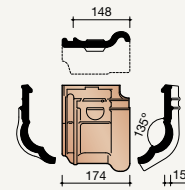

8550 Chaperonpan met dubbele wel

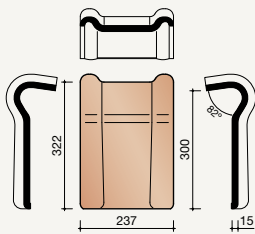

8500 Chaperonpan

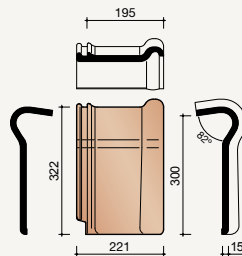

8530 Driekwart chaperonpan

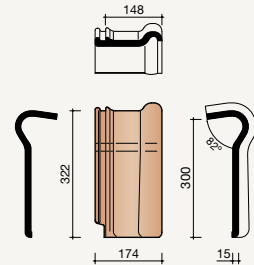

*Ook leverbaar in standaard uitvoering (pag.5)

Overige hulpstukken

8610 Ventilatie-/haakdoorvoerpan met rooster 12cm²

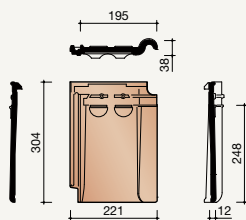

8728 Dakdoorvoer incl. aansluiting Ø 125 mm

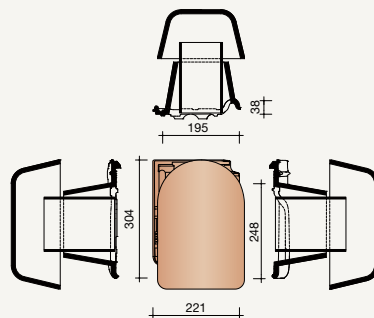

8870 Hoekstuk voor gevelbekleding

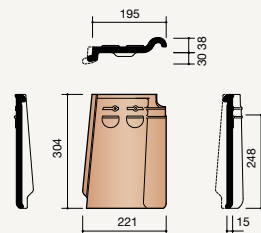

Vorstenhoeden

vorstenhoed tussen 1 vorst en 2 hoekkepers

vorstenhoed tussen 4 hoekkepers

5740 Vorstenhoed 1x 1200 en 2x 3100

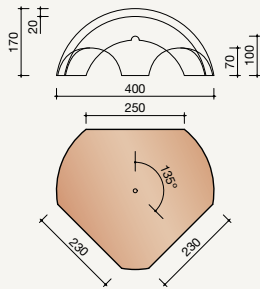

verbindingstuk tussen 2 vorsten
en 1 hoekkeper

5500 Vorstenhoed 3x 1200

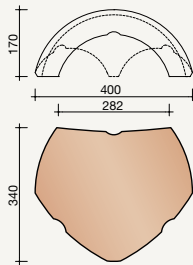

verbindingstuk tussen 3 vorsten

5630 Vorstenhoed 4x 3100

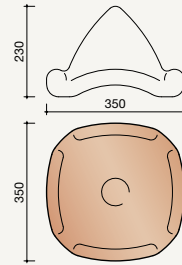

5120 Verbindingsstuk 2x 1200 en 1x 3100

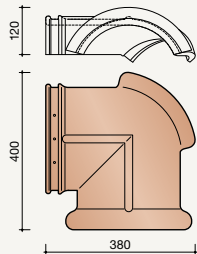

5020 Verbindingsstuk 3x 1200

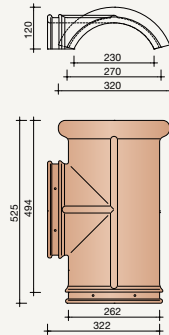



Datum: Januari 2026

T 088 - 118 51 11, E info.nl@wienerberger.com, wienerberger.nl